

CD4093BC Quad 2-Input NAND Schmitt Trigger

General Description

The CD4093B consists of four Schmitt-trigger circuits. Each circuit functions as a 2-input NAND gate with Schmitt-trigger action on both inputs. The gate switches at different points for positive and negative-going signals. The difference between the positive (V_T^+) and the negative voltage (V_T^-) is defined as hysteresis voltage (V_H).

All outputs have equal source and sink currents and conform to standard B-series output drive (see Static Electrical Characteristics).

Features

- Wide supply voltage range: 3.0V to 15V
- Schmitt-trigger on each input with no external components
- Noise immunity greater than 50%
- Equal source and sink currents
- No limit on input rise and fall time
- Standard B-series output drive
- Hysteresis voltage (any input) $T_A = 25^\circ\text{C}$

Typical	$V_{DD} = 5.0\text{V}$	$V_H = 1.5\text{V}$
	$V_{DD} = 10\text{V}$	$V_H = 2.2\text{V}$
	$V_{DD} = 15\text{V}$	$V_H = 2.7\text{V}$
Guaranteed	$V_H = 0.1 V_{DD}$	

Applications

- Wave and pulse shapers
- High-noise-environment systems
- Monostable multivibrators
- Astable multivibrators
- NAND logic

Ordering Code:

Order Number	Package Number	Package Description
CD4093BCM	M14A	14-Lead Small Outline Integrated Circuit (SOIC), JEDEC MS-012, 0.150" Narrow
CD4093BCN	N14A	14-Lead Plastic Dual-In-Line Package (PDIP), JEDEC MS-001, 0.300" Wide

Devices also available in Tape and Reel. Specify by appending the suffix letter "X" to the ordering code.

Connection Diagram

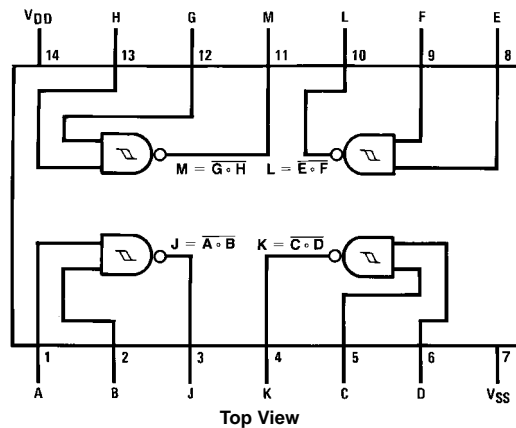

Absolute Maximum Ratings (Note 1)

(Note 2)

DC Supply Voltage (V_{DD})	-0.5 to +18 V_{DC}
Input Voltage (V_{IN})	-0.5 to V_{DD} +0.5 V_{DC}
Storage Temperature Range (T_S)	-65°C to +150°C
Power Dissipation (P_D)	
Dual-In-Line	700 mW
Small Outline	500 mW
Lead Temperature (T_L)	
(Soldering, 10 seconds)	260°C

Recommended Operating Conditions (Note 2)

DC Supply Voltage (V_{DD})	3 to 15 V_{DC}
Input Voltage (V_{IN})	0 to V_{DD} V_{DC}
Operating Temperature Range (T_A)	-55°C to +125°C

Note 1: "Absolute Maximum Ratings" are those values beyond which the safety of the device cannot be guaranteed; they are not meant to imply that the devices should be operated at these limits. The table of "Recommended Operating Conditions" and "Electrical Characteristics" provides conditions for actual device operation.

Note 2: $V_{SS} = 0V$ unless otherwise specified.

DC Electrical Characteristics (Note 2)

Symbol	Parameter	Conditions	-55°C		+25°C			+125°C		Units
			Min	Max	Min	Typ	Max	Min	Max	
I_{DD}	Quiescent Device Current	$V_{DD} = 5V$ $V_{DD} = 10V$ $V_{DD} = 15V$		0.25 0.5 1.0				0.25 0.5 1.0	7.5 15.0 30.0	μA
V_{OL}	LOW Level Output Voltage	$V_{IN} = V_{DD}$, $ I_{OL} < 1 \mu A$ $V_{DD} = 5V$ $V_{DD} = 10V$ $V_{DD} = 15V$		0.05 0.05 0.05		0 0 0		0.05 0.05 0.05	0.05 0.05 0.05	V
V_{OH}	HIGH Level Output Voltage	$V_{IN} = V_{SS}$, $ I_{OH} < 1 \mu A$ $V_{DD} = 5V$ $V_{DD} = 10V$ $V_{DD} = 15V$	4.95 9.95 14.95		4.95 9.95 14.95	5 10 15		4.95 9.95 14.95		V
V_{T-}	Negative-Going Threshold Voltage (Any Input)	$ I_{OL} < 1 \mu A$ $V_{DD} = 5V$, $V_O = 4.5V$ $V_{DD} = 10V$, $V_O = 9V$ $V_{DD} = 15V$, $V_O = 13.5V$	1.3 2.85 4.35	2.25 4.5 6.75	1.5 3.0 4.5	1.8 4.1 6.3	2.25 4.5 6.75	1.5 3.0 4.5	2.3 4.65 6.9	V
V_{T+}	Positive-Going Threshold Voltage (Any Input)	$ I_{OL} < 1 \mu A$ $V_{DD} = 5V$, $V_O = 0.5V$ $V_{DD} = 10V$, $V_O = 1V$ $V_{DD} = 15V$, $V_O = 1.5V$	2.75 5.5 8.25	3.6 7.15 10.65	2.75 5.5 8.25	3.3 6.2 9.0	3.5 7.0 10.5	2.65 5.35 8.1	3.5 7.0 10.5	V
V_H	Hysteresis ($V_{T+} - V_{T-}$) (Any Input)	$V_{DD} = 5V$ $V_{DD} = 10V$ $V_{DD} = 15V$	0.5 1.0 1.5	2.35 4.3 6.3	0.5 1.0 1.5	1.5 2.2 2.7	2.0 4.0 6.0	0.35 0.70 1.20	2.0 4.0 6.0	V
I_{OL}	LOW Level Output Current (Note 3)	$V_{IN} = V_{DD}$ $V_{DD} = 5V$, $V_O = 0.4V$ $V_{DD} = 10V$, $V_O = 0.5V$ $V_{DD} = 15V$, $V_O = 1.5V$	0.64 1.6 4.2		0.51 1.3 3.4	0.88 2.25 8.8		0.36 0.9 2.4		mA
I_{OH}	HIGH Level Output Current (Note 3)	$V_{IN} = V_{SS}$ $V_{DD} = 5V$, $V_O = 4.6V$ $V_{DD} = 10V$, $V_O = 9.5V$ $V_{DD} = 15V$, $V_O = 13.5V$	-0.64 -1.6 -4.2		0.51 -1.3 -3.4	-0.88 -2.25 -8.8		-0.36 -0.9 -2.4		mA
I_{IN}	Input Current	$V_{DD} = 15V$, $V_{IN} = 0V$ $V_{DD} = 15V$, $V_{IN} = 15V$		-0.1 0.1		-10^{-5} 10^{-5}	-0.1 0.1		-1.0 1.0	μA

Note 3: I_{OH} and I_{OL} are tested one output at a time.

AC Electrical Characteristics (Note 4)

$T_A = 25^\circ\text{C}$, $C_L = 50\text{ pF}$, $R_L = 200\text{ k}$, Input t_r , $t_f = 20\text{ ns}$, unless otherwise specified

Symbol	Parameter	Conditions	Min	Typ	Max	Units
t_{PHL} , t_{PLH}	Propagation Delay Time	$V_{DD} = 5\text{V}$ $V_{DD} = 10\text{V}$ $V_{DD} = 15\text{V}$		300 120 80	450 210 160	ns
t_{THL} , t_{TLH}	Transition Time	$V_{DD} = 5\text{V}$ $V_{DD} = 10\text{V}$ $V_{DD} = 15\text{V}$		90 50 40	145 75 60	ns
C_{IN}	Input Capacitance	(Any Input)		5.0	7.5	pF
C_{PD}	Power Dissipation Capacitance	(Per Gate)		24		pF

Note 4: AC Parameters are guaranteed by DC correlated testing.

Typical Applications

Gated Oscillator

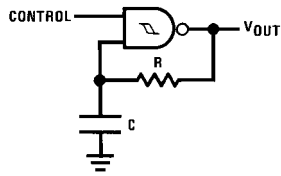

Assume $t_1 + t_2 \gg t_{PHL} + t_{PLH}$ then:

$$t_0 = RC \ln [V_{DD}/V_T^-]$$

$$t_1 = RC \ln [(V_{DD} - V_T^-)/(V_{DD} - V_T^+)]$$

$$t_2 = RC \ln [V_T^+/V_T^-]$$

$$f = \frac{1}{t_1 + t_2} = \frac{1}{RC \ln \frac{(V_T^+)(V_{DD} - V_T^-)}{(V_T^-)(V_{DD} - V_T^+)}}$$

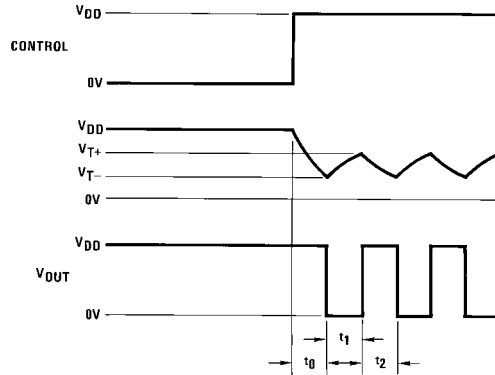

Gated One-Shot

(a) Negative-Edge Triggered

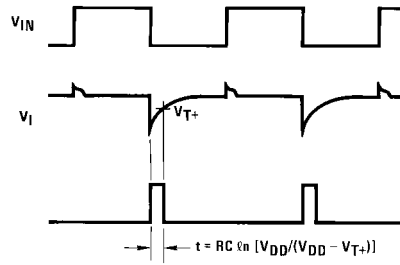
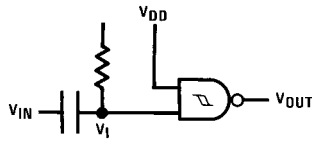

(b) Positive-Edge Triggered

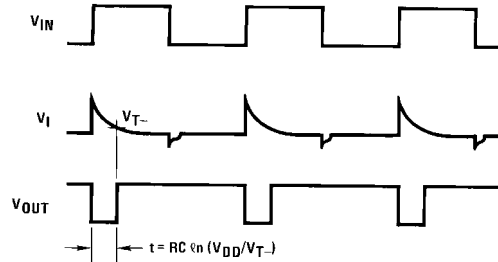
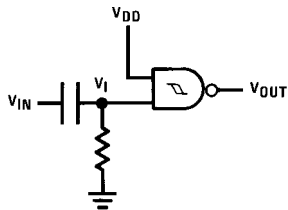

Typical Performance Characteristics

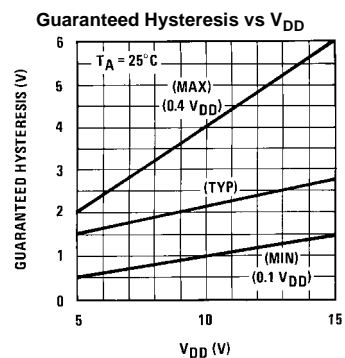
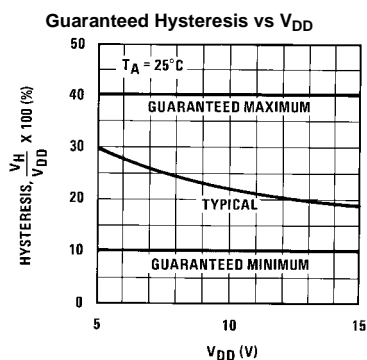
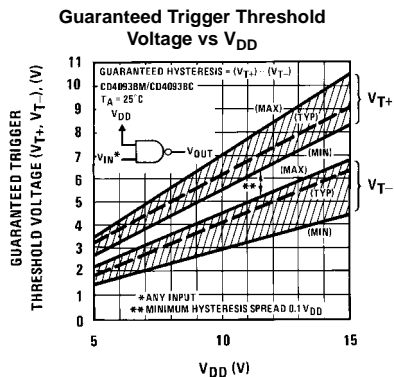
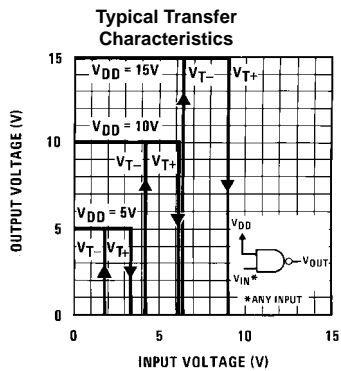

Input and Output Characteristics

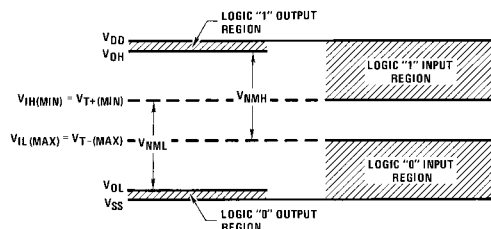
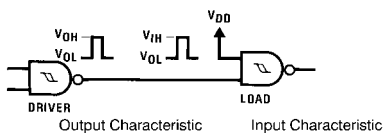

$$V_{NML} = V_{IH(MIN)} - V_{OL} \cong V_{IH(MIN)} = V_{T+(MIN)}$$

$$V_{NMH} = V_{OH} - V_{IL(MAX)} \cong V_{DD} - V_{IL(MAX)} = V_{DD} - V_{T-(MAX)}$$

AC Test Circuits and Switching Time Waveforms

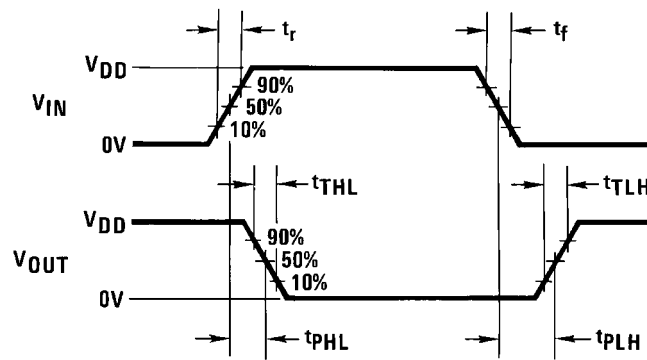
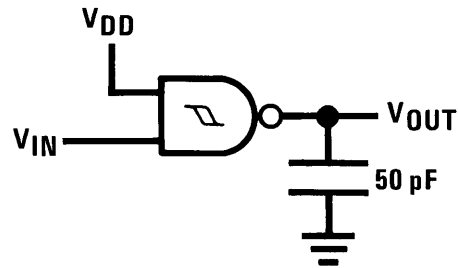

Physical Dimensions inches (millimeters) unless otherwise noted



**14-Lead Small Outline Integrated Circuit (SOIC), JEDEC MS-012, 0.150" Narrow
Package Number M14A**

M14A (REV. H)

Physical Dimensions inches (millimeters) unless otherwise noted (Continued)

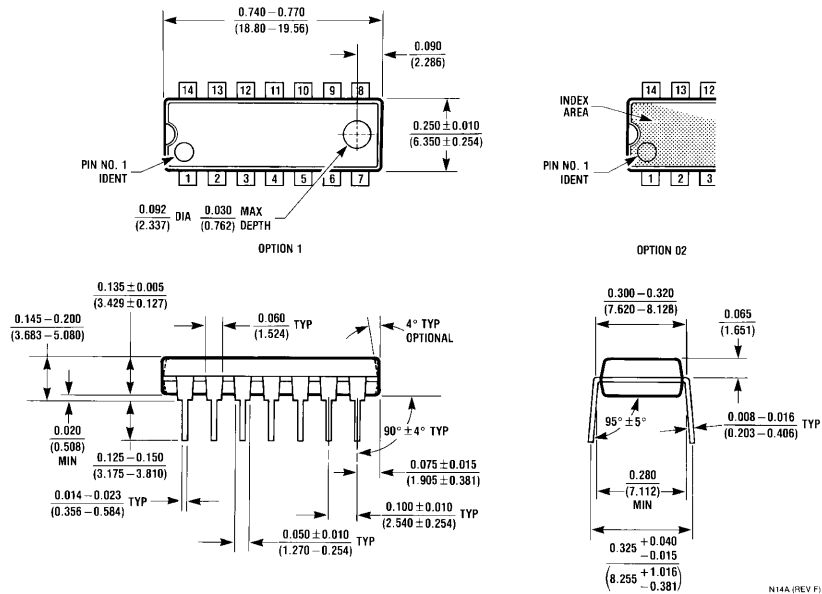

Fairchild does not assume any responsibility for use of any circuitry described, no circuit patent licenses are implied and Fairchild reserves the right at any time without notice to change said circuitry and specifications.

LIFE SUPPORT POLICY

FAIRCHILD'S PRODUCTS ARE NOT AUTHORIZED FOR USE AS CRITICAL COMPONENTS IN LIFE SUPPORT DEVICES OR SYSTEMS WITHOUT THE EXPRESS WRITTEN APPROVAL OF THE PRESIDENT OF FAIRCHILD SEMICONDUCTOR CORPORATION. As used herein:

1. Life support devices or systems are devices or systems which, (a) are intended for surgical implant into the body, or (b) support or sustain life, and (c) whose failure to perform when properly used in accordance with instructions for use provided in the labeling, can be reasonably expected to result in a significant injury to the user.
2. A critical component in any component of a life support device or system whose failure to perform can be reasonably expected to cause the failure of the life support device or system, or to affect its safety or effectiveness.

www.fairchildsemi.com